

Notice: You cannot copy or search for text in this PDF file, because this PDF file is converted from the scanned image of printed materials.

P1 98.2

N-CHANNEL POWER MOS FET ARRAY
SWITCHING TYPE

DESCRIPTION

The μ PA1501 is N-channel Power MOS FET Array that built in 4 circuits and surge absorber designed for solenoid, motor and lamp driver.

FEATURES

- 4 V driving is possible
- Low On-state Resistance
 $R_{DS(on)} \leq 0.42 \Omega$ MAX. ($V_{GS} = 10 V, I_D = 2 A$)
 $R_{DS(on)} \leq 0.49 \Omega$ MAX. ($V_{GS} = 4 V, I_D = 2 A$)
- Surge Absorber, built in.

ORDERING INFORMATION

Part Number	Package	Quality Grade
μ PA1501H	12-Pin SIP	Standard

Please refer to "Quality grade on NEC Semiconductor Devices" (Document number IEI-1209) published by NEC Corporation to know the specification of quality grade on the devices and its recommended applications.

ABSOLUTE MAXIMUM RATINGS ($T_a = 25^\circ C$)

Drain to Source Voltage	V_{DSS}	120	V
Gate to Source Voltage	$V_{GSS(AC)}$	+20, -10	V
Drain Current (DC)	$I_{D(DC)}$	± 3.0	A/unit
Drain Current (pulse)	$I_{D(pulse)^*}$	± 12	A/unit
Repetitive Peak Reverse Voltage	V_{RRM}	140	V
Diode Forward Current	$I_{F(AV)}$	3.0	A/unit
Total Power Dissipation (4 circuits)	P_T	4.0	W
< $T_a = 25^\circ C$ >			
Channel Temperature	T_{ch}	150	$^\circ C$
Storage Temperature	T_{stg}	-55 to +150	$^\circ C$

* $PW \leq 10 \mu s$, Duty Cycle $\leq 1\%$

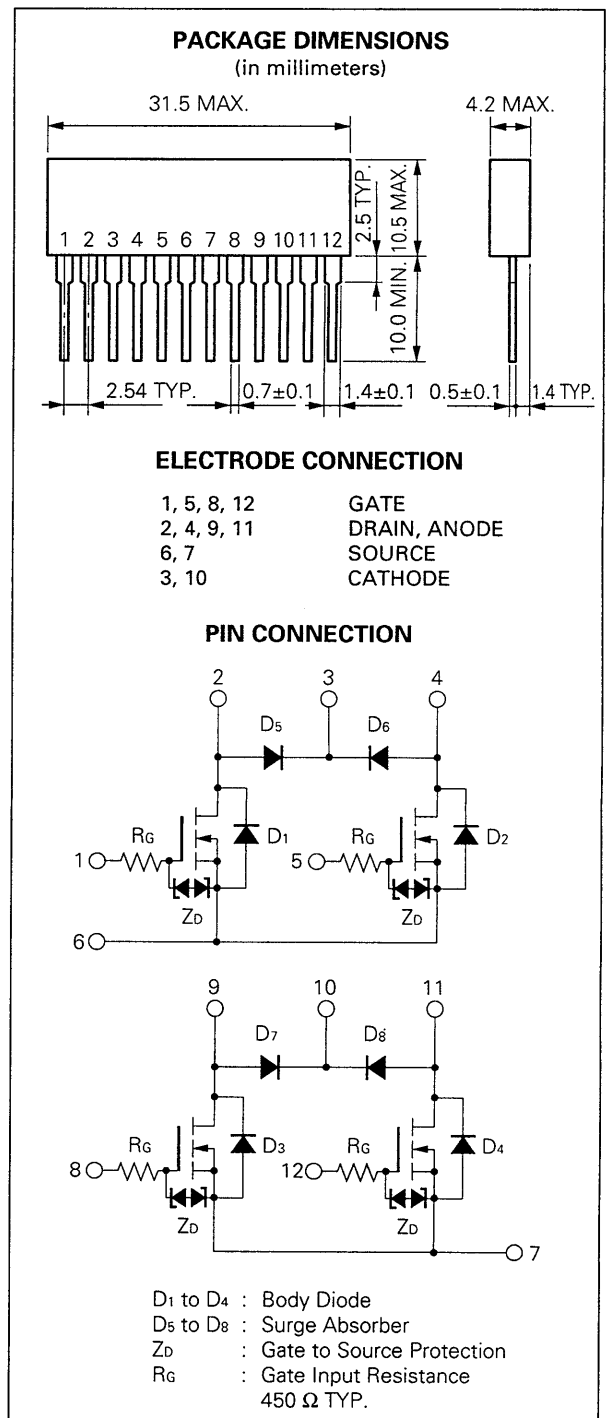

ELECTRICAL CHARACTERISTICS (T_a = 25 °C)

CHARACTERISTIC	SYMBOL	MIN.	TYP.	MAX.	UNIT	TEST CONDITIONS
Drain Leakage Current	I _{DSS}			10	μA	V _{DS} = 120 V, V _{GS} = 0
Gate to Source Leakage Current	I _{GSS}			±10	μA	V _{GS} = ±20 V, V _{DS} = 0
Gate to Source Cutoff Voltage	V _{GS(off)}	1.0		2.5	V	V _{DS} = 10 V, I _D = 1 mA
Forward Transfer Admittance	y _{fs}	2.2			S	V _{DS} = 10 V, I _D = 2 A
Drain to Source On-state Resistance	R _{DS(on)1}		0.42	0.55	Ω	V _{GS} = 10 V, I _D = 2 A
Drain to Source On-state Resistance	R _{DS(on)2}		0.49	0.65	Ω	V _{GS} = 4 V, I _D = 2 A
Input Capacitance	C _{iss}		620		pF	V _{DS} = 10 V V _{GS} = 0 f = 1.0 MHz
Output Capacitance	C _{oss}		140		pF	
Reverse Transfer Capacitance	C _{rss}		10		pF	
Turn-On Delay Time	t _{d(on)}		75		ns	I _D = 2 A V _{GS} = 10 V V _{DD} = 30 V R _L = 15 Ω See Fig. 1
Rise Time	t _r		60		ns	
Turn-Off Delay Time	t _{d(off)}		900		ns	
Fall Time	t _f		200		ns	
Total Gate Charge	Q _G		13		nC	V _{GS} = 10 V I _D = 3 A V _{DD} = 48 V See Fig. 2
Gate to Source Charge	Q _{GS}		3		nC	
Gate to Drain Charge	Q _{GD}		2		nC	

SURGE ABSORBER (Diode, built in) 1 Unit

Repetitive Peak Reverse Current	I _{RRM}			10	μA	V _R = 140 V
Diode Forward Voltage	V _F		1.2		V	I _F = 3 A, V _{GS} = 0

Fig. 1 Switching Test Circuit

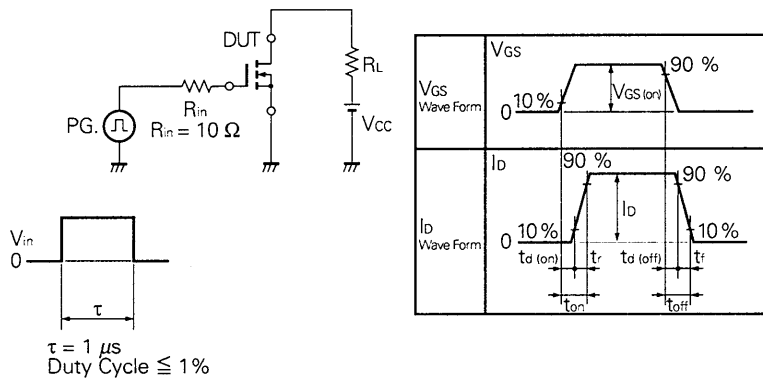
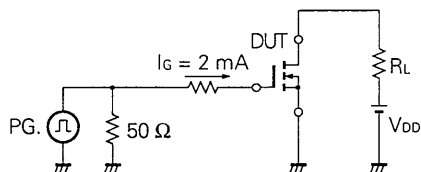
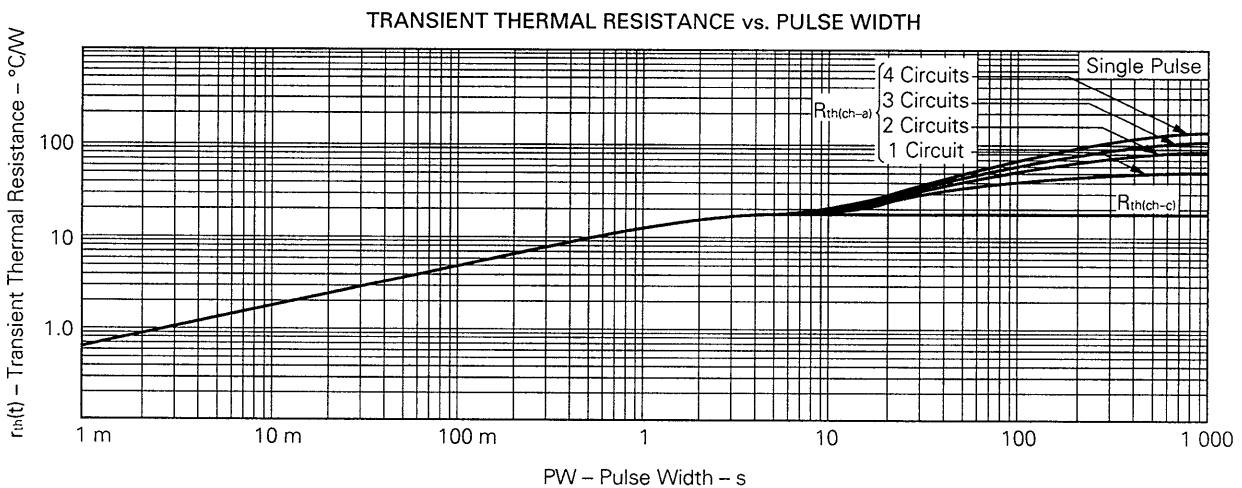
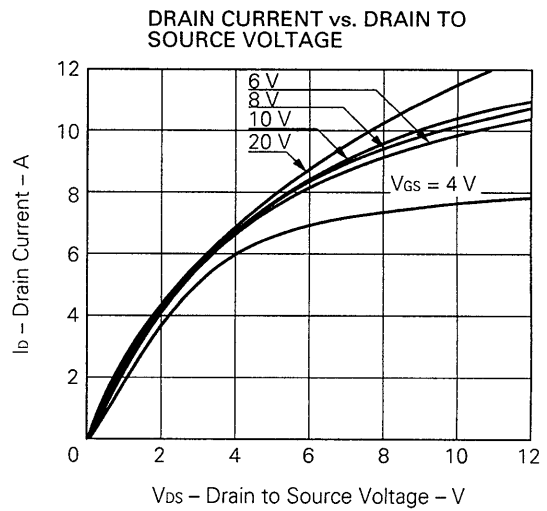
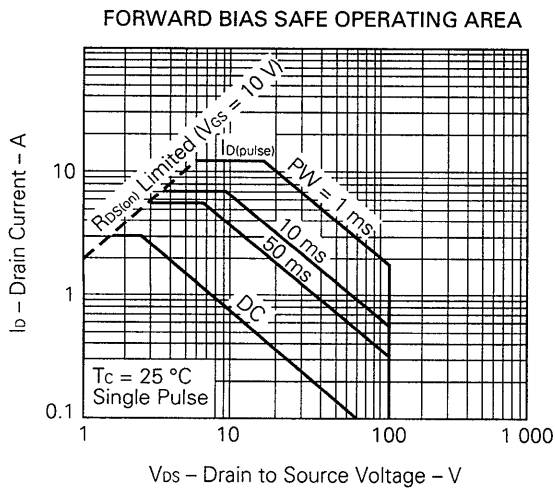
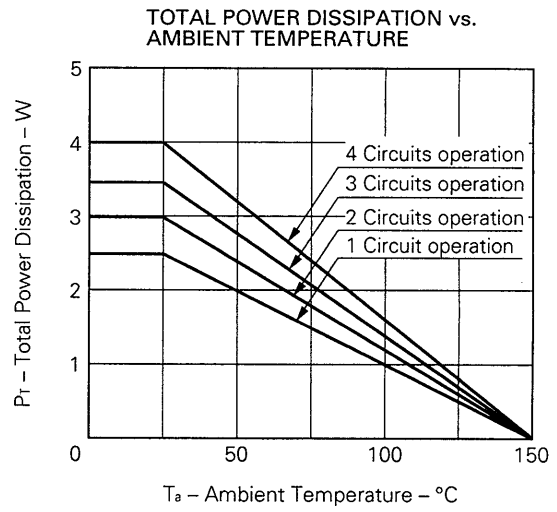
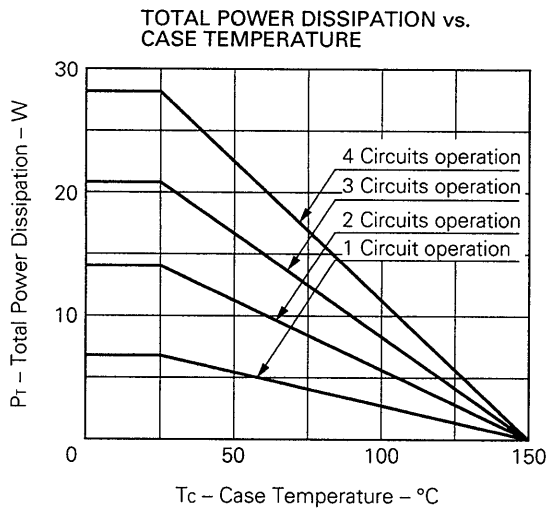

Fig. 2 Gate Charge Test Circuit



TYPICAL CHARACTERISTICS ($T_a = 25^\circ\text{C}$)



DRAIN TO SOURCE VOLTAGE vs. DRAIN CURRENT

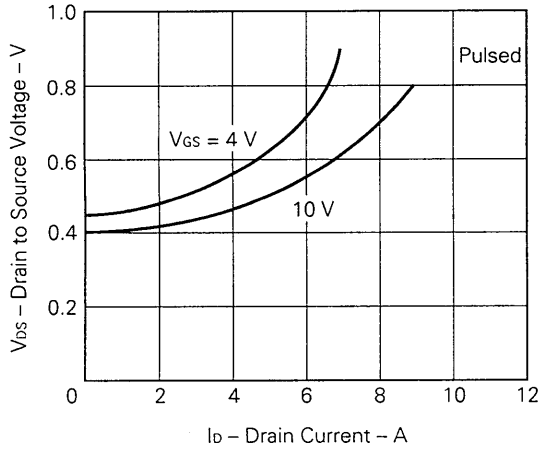

DRAIN TO SOURCE VOLTAGE vs. GATE TO SOURCE VOLTAGE

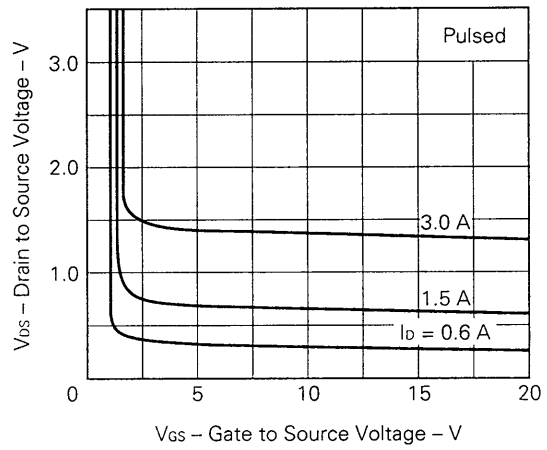

TRANSFER CHARACTERISTIC

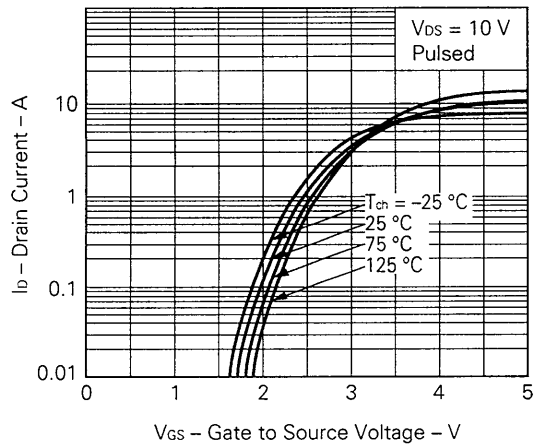

SOURCE TO DRAIN DIODE FORWARD VOLTAGE

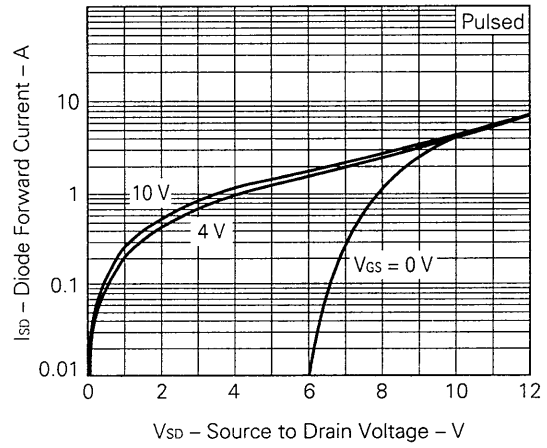

FORWARD TRANSFER ADMITTANCE vs. DRAIN CURRENT

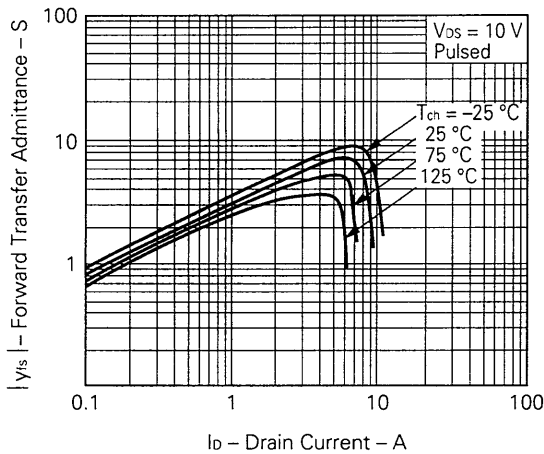

CAPACITANCE vs. DRAIN TO SOURCE VOLTAGE

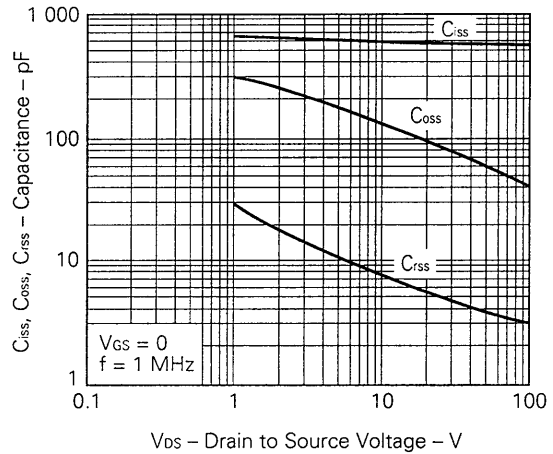

GATE TO SOURCE CUTOFF VOLTAGE vs. CHANNEL TEMPERATURE

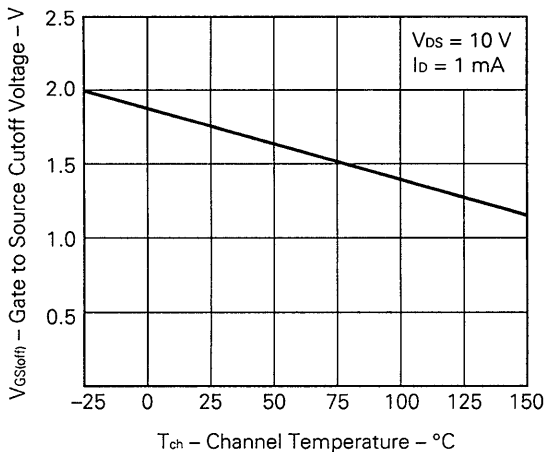

DRAIN TO SOURCE ON-STATE RESISTANCE vs. CHANNEL TEMPERATURE

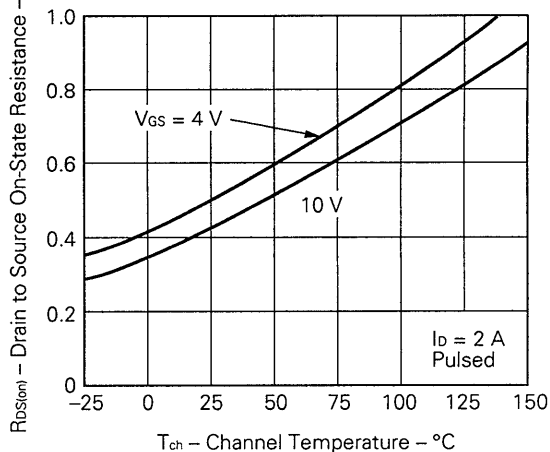

SWITCHING TIME vs. DRAIN CURRENT

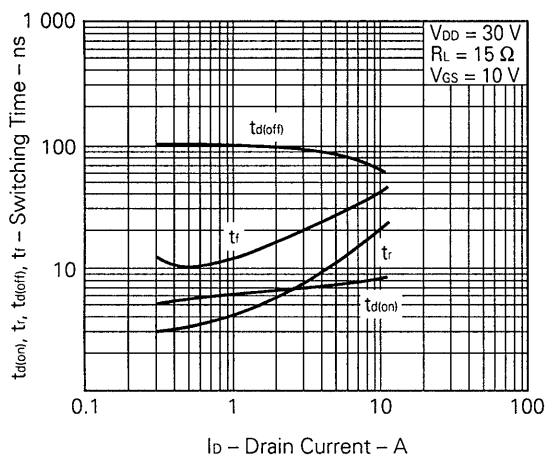

DYNAMIC INPUT CHARACTERISTIC

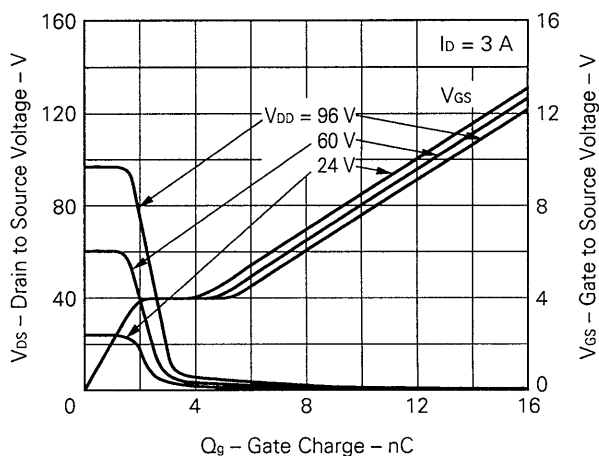

Reference

Application note name	No.
Quality control of NEC semiconductors devices.	TEI-1202
Quality control guide of semiconductors devices.	MEI-1202
Assembly manual of semiconductors devices.	IEI-1207
Safe operating area of Power MOS FET	TEA-1034
Application circuit using Power MOS FET	TEB-1035

No part of this document may be copied or reproduced in any form or by any means without the prior written consent of NEC Corporation. NEC Corporation assumes no responsibility for any errors which may appear in this document.

NEC Corporation does not assume any liability for infringement of patents, copyrights or other intellectual property rights of third parties by or arising from use of a device described herein or any other liability arising from use of such device. No license, either express, implied or otherwise, is granted under any patents, copyrights or other intellectual property rights of NEC Corporation or others.

The devices listed in this document are not suitable for use in aerospace equipment, submarine cables, nuclear reactor control systems and life support systems. If customers intend to use NEC devices for above applications or they intend to use "Standard" quality grade NEC devices for applications not intended by NEC, please contact our sales people in advance.

Application examples recommended by NEC Corporation.

Standard: Computer, Office equipment, Communication equipment, Test and Measurement equipment, Machine tools, Industrial robots, Audio and Visual equipment, Other consumer products, etc.

Special: Automotive and Transportation equipment, Traffic control systems, Antidisaster systems, Anticrime systems, etc.